

Domestic hot water pumps

CompAX BLUE



Übersicht

Type	Art. no.	Nominal width	Flow head H max.	Overall length	Threaded connection	Operating pressure max. bar	EEI
		DN	m	mm			
CompAX 20-1 120 BLUE	7000001511	20	1	120	G 1 1/4"	10	ECO Design
CompAX 20-1 150 BLUE	7000001512	20	1	150	G 1 1/4"	10	ECO Design
CompAX 20-2.5 120 BLUE	7000001530	20	2.5	120	G 1 1/4"	10	ECO Design
CompAX 20-4 120 BLUE	7000001513	20	4	120	G 1 1/4"	10	ECO Design
CompAX 20-4 150 BLUE	7000001514	20	4	150	G 1 1/4"	10	ECO Design
CompAX 20-6 150 BLUE	7000001516	20	6	150	G 1 1/4"	10	ECO Design
CompAX 25-4 180 BLUE	7000001515	25	4	180	G 1 1/2"	10	ECO Design
CompAX 25-6 180 BLUE	7000001517	25	6	180	G 1 1/2"	10	ECO Design

CompAX 20-4 120 BLUE

CompAX 20-4 150 BLUE

Nominal width	DN 20
Flow head H max.	4 m
Overall length	120 150 mm
Threaded connection	G 1 1/4"
Operating pressure max.	10 bar
Media temperature min.	+ 2°C
Media temperature max.	+85°C
Ambient temperature	0°C bis 40°C
Water hardness max. at 65 °C	35°fH/20°dH
Water hardness max. at 85 °C	25°fH/14°dH
Net weight	1.8 kg
Gross weight	2.0 kg

Electrical data

Voltage	1x230 V
Frequency	50/60 Hz
Power P ₁	4-22 W
Nominal current	0.05-0.19 A
Motor protection	integriert

Required operating pressure at 500m a.s.l.

at a water temp. of 75 °C	0.05 bar
at a water temp. of 85 °C	0.28 bar
for every ±100 m of altitude	0.01 bar

Connction diagram

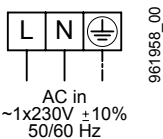

L, N, PE Netzanschluss

Included in the scope of delivery

- Heat insulation shell
- Biral Connector
- AFM seal

Accessories

- Angle plug
- Blocking set (non-return valve and ball valve)

Remarks

Pump housing: bronze

Type	Art. no.
CompAX 20-4 120 BLUE	7000001513
CompAX 20-4 150 BLUE	7000001514

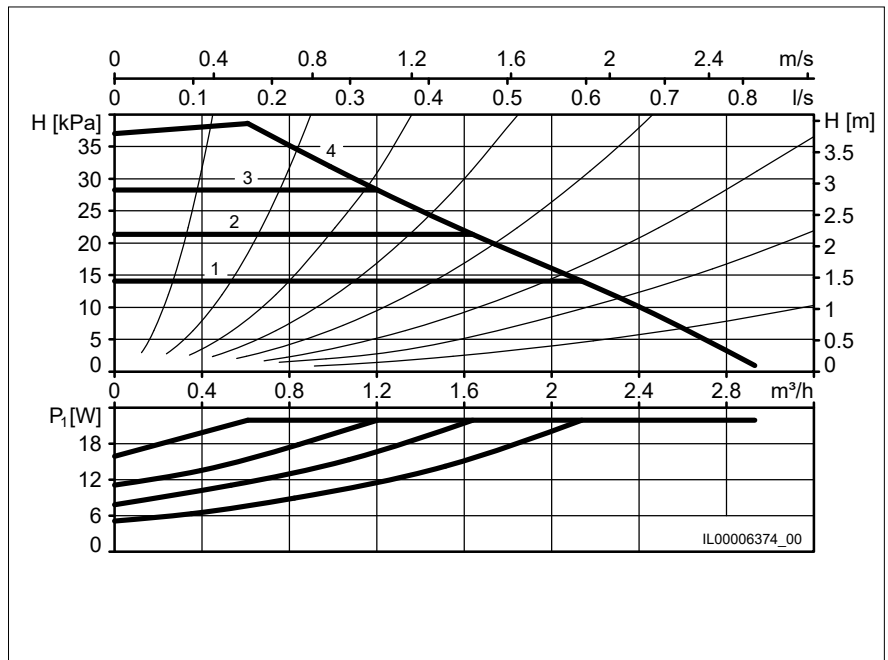
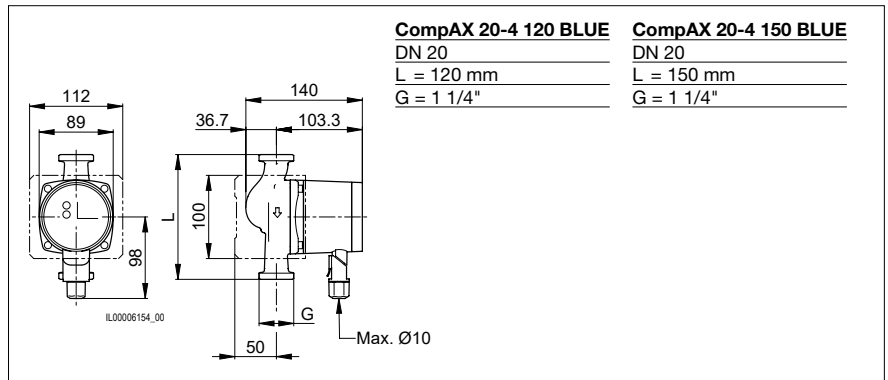

IL00006374_00

Accessories

Shut-off set 1 1/4" x 1/2", 70 mm

Consisting of non-return valve and ball valve.

Material: brass
 Article no: 7000001532

Ball valve

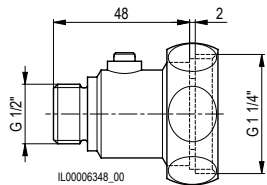

Non-return valve

Opening pressure: 20-35 mbar

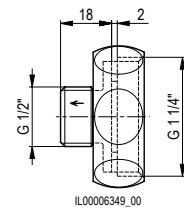

Pressure loss curve

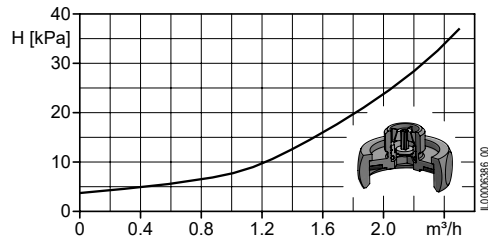

Dimensional drawing

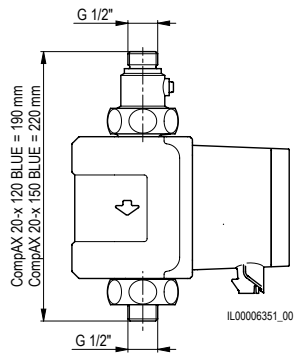

Exchange guide

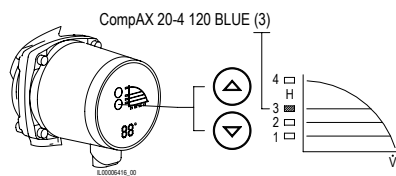

Stock	Replacement	Shut-off set
AX 15-0.7 BLUE RV KH	= CompAX 20-1 120 BLUE (4)	+ 1 1/4" x 1/2", 70 mm
AX 15-1.6 BLUE RV KH	= CompAX 20-2.5 120 BLUE (3)	+ 1 1/4" x 1/2", 70 mm
AX 15-2.5 BLUE RV KH	= CompAX 20-4 120 BLUE (3)	+ 1 1/4" x 1/2", 70 mm

Shut-off set 1 1/4" x 1", 110 mm

Consisting of non-return valve and ball valve.

Material: brass
 Article no: 1161910150

Ball valve

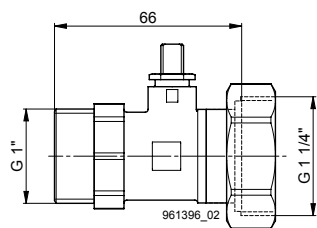

Non-return valve

Opening pressure: 20-35 mbar

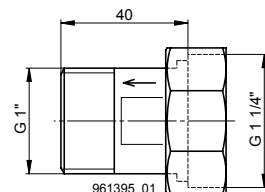

Dim. drawing AX...

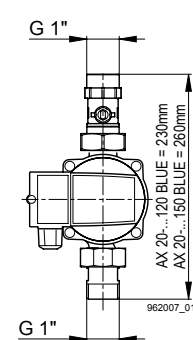

Dim. drawing CompAX...

